

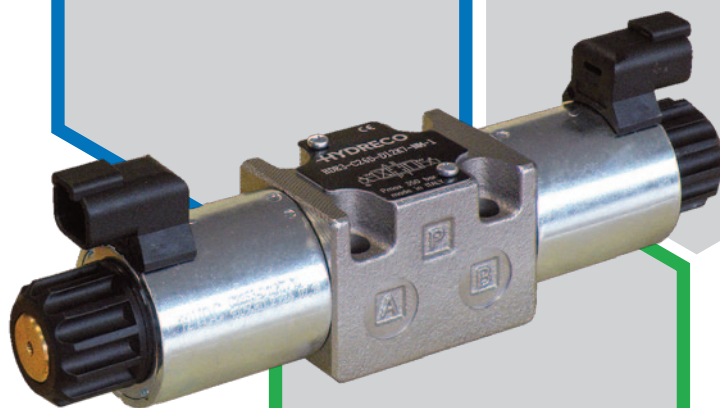

HDE3

PROPORTIONAL
DIRECTIONAL VALVE

350 bar 40 l/min



TECHNICAL CATALOGUE

INTRODUCTION

The HDE3 valves are proportional directional valves, direct operated, with porting pattern compliant to ISO 4401-03 standards.

These valves are designed to control the direction and oil flow rate based on the amount of current supplied to the solenoid.

In event of a loss in electrical power, the centring springs will return the valve spool to the center position.

The valve solenoids can be driven by a variable current power supply or by use of external power amplifiers or el cards designed to maximize the valve performance.

A variety of manual overrides are also available.

FLUIDS

Use mineral oil-based hydraulic fluids HL or HM type, according to ISO 6743-4. For these fluids, use NBR seals.

For fluids HFDR type (phosphate esters) use FPM seals (code V). For the use of other kinds of fluid such as HFA, HFB, HFC, please consult our technical department.

Using fluids at temperatures higher than 80 °C (180 °F) causes the accelerated degradation of seals as well as the fluid physical and chemical properties.

From a safety standpoint, temperatures above 55 °C (130 °F) are not recommended.

OPERATING PARAMETERS

MAXIMUM OPERATING PRESSURE	P - A - B ports	350 bar	5000 psi
	T port	160 bar	1500 psi
FLOW CAPACITY WITH Δp 10 BAR (145 PSI)		1 l/min	0.26 gpm
		4 l/min	1.06 gpm
		8 l/min	2.1 gpm
		16 l/min	4.2 gpm
		26 l/min	7.0 gpm
MOUNTING SURFACE	ISO 4401-03-02-0-05 NFPA D03		

STEP RESPONSE	0 → 100%	50 ms	
	100 → 0%	40 ms	
HYSTERESIS	% of Q max	< 6%	
REPEATABILITY	% of Q max	< ± 2%	
VOLTAGE		12V DC 24V DC	
COIL CONNECTION		DIN 43650	DT04-2P
PROTECTION	according to IEC 60529	IP65	IP65/67
WEIGHT	single solenoid	1.6 kg	3.5 lbs
	double solenoid	2 kg	4.4 lbs

RANGE TEMPERATURES:	ambient	-20 to +54 °C	-4 to +130 °F
	fluid	-20 to +82 °C	-4 to +180 °F
FLUID VISCOSITY	range	10 - 400 cSt	60 - 1900 SUS
	recommended	25 cSt	120 SUS
FLUID CONTAMINATION	ISO 4406:1999 class 18/16/13		

HYDRAULIC SYMBOL (TYPICAL)

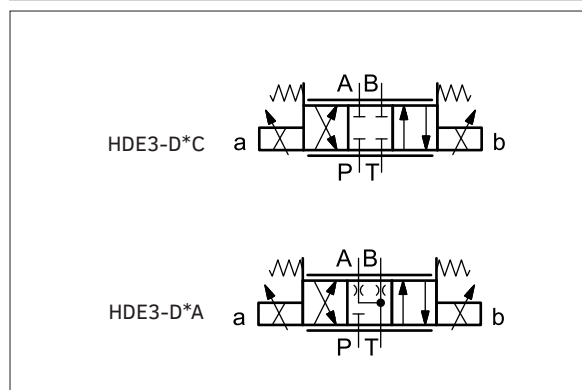

HDE3 - ■■■ - ■■■ - ■■■ - 1

design mark

NOMINAL FLOW	
with Δp P-T 10 bar (145 psi)	
01	1 l/min (0.26 gpm)
04	4 l/min (1.06 gpm)
08	8 l/min (2.1 gpm)
16	16 l/min (4.2 gpm)
26	26 l/min (7.0 gpm)

COIL	
K1	DIN 43650
K2	AMP Junior
K7	DT04-2P 'deutsch'
WK1	DIN 43650 zinc-nickel plated
WK7	DT04-2P 'deutsch' zinc-nickel plated

MANUAL OVERRIDE	
M	built-in with the tube, pin (standard)
B	built-in with the tube, boot protected (standard with WK* coils)
S	screw
K	knob, turning
K2	knob, twist and lock
L	hand lever
L1	long hand lever

FUNCTION	
D	<p>double solenoid 3 position - spring centred</p>
A	<p>single solenoid at side A 2 position - spring return</p>
B	<p>single solenoid at side B 2 position - spring return</p>

VOLTAGE	
D12	12 V DC solenoid
D24	24 V DC solenoid

SEAL	
N	NBR (standard)
V	Viton

SPOOLS			
	SYMBOL	DESCRIPTION	APPLICATION
C		closed centre	meter in / meter out
A		open centre	

CODE EXAMPLE:
HDE3 - D26C - D12K7 - NM - 1

Flow characteristic curves obtained with mineral oil with viscosity of 36 cSt (170 SUS) at 50 °C (122 °F) and 24V DC valve; the Δp values are measured between P and T (full loop) valve ports.

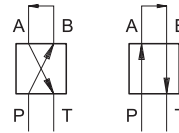

bar / PSI conversion:

- 10 bar = 145 PSI
- 30 bar = 435 PSI
- 70 bar = 1015 PSI
- 140 bar = 2030 PSI
- 210 bar = 3045 PSI

01C / 01A

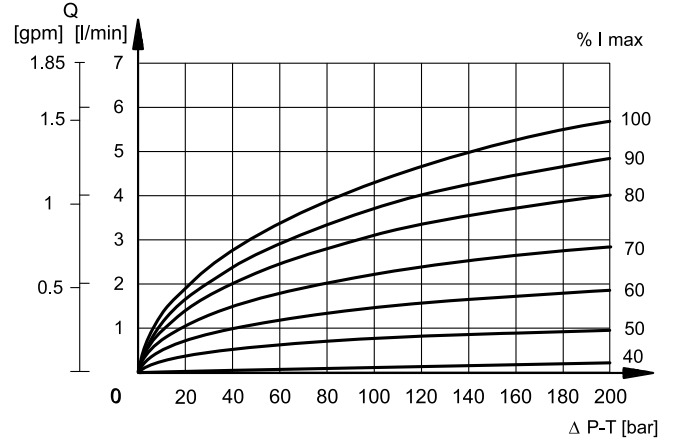
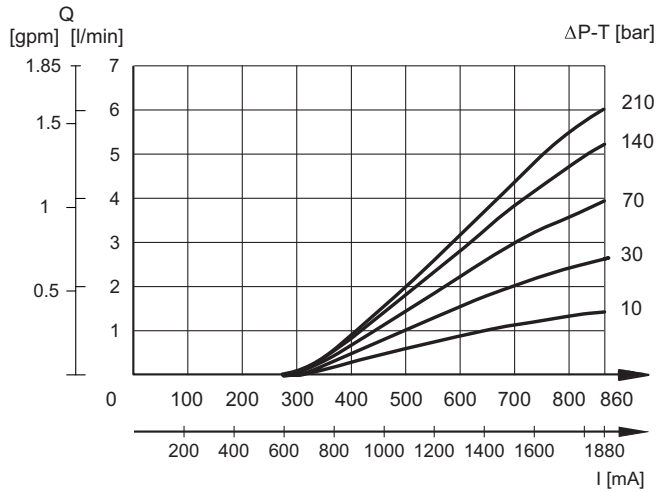

04C / 04A

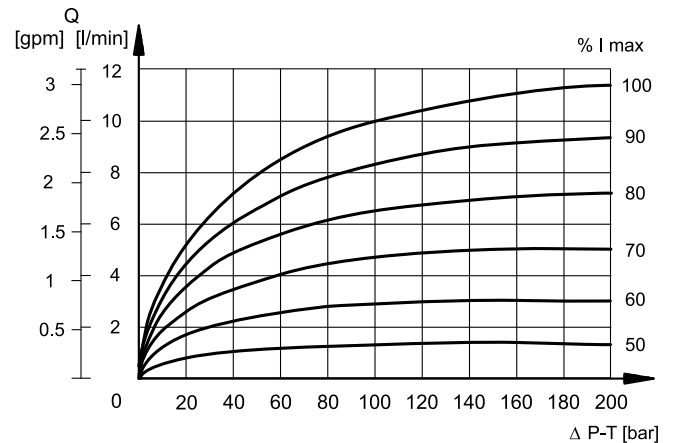
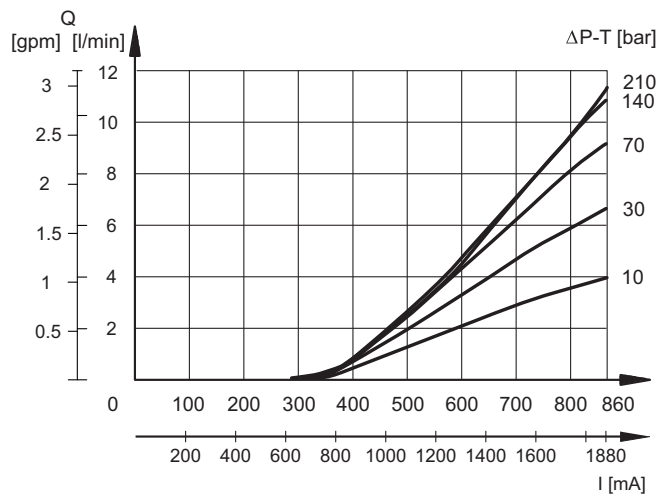

08C / 08A

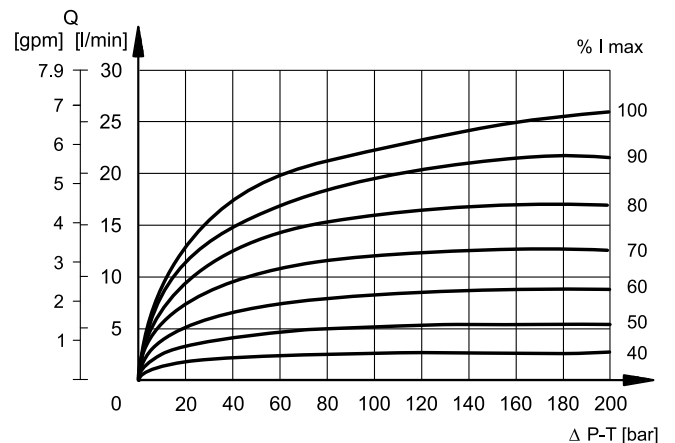
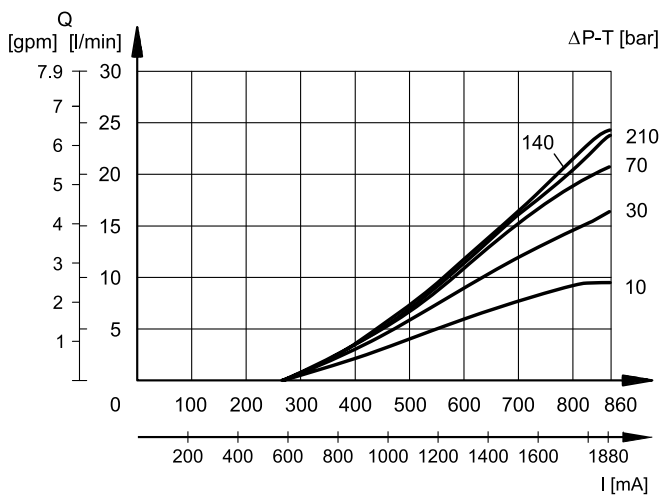

16C / 16A

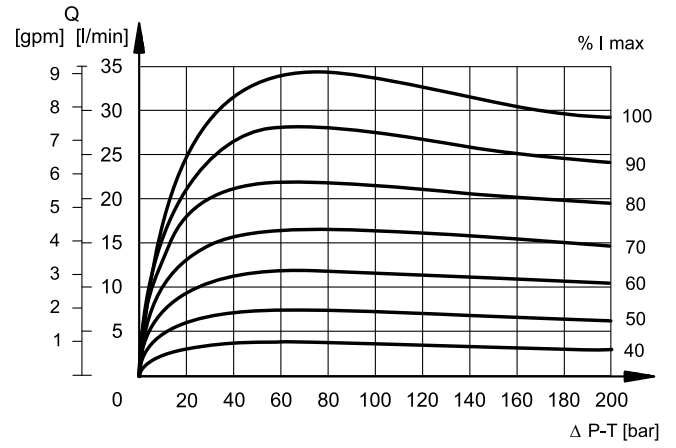
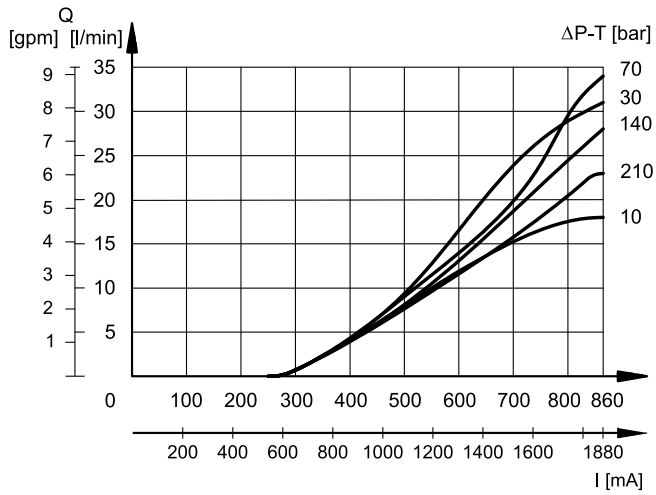

26C / 26A

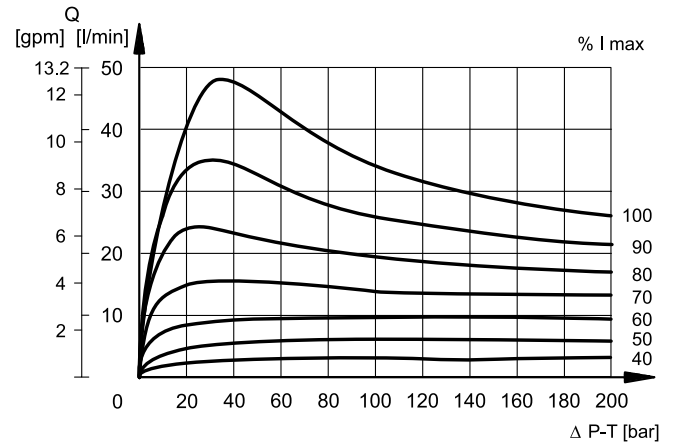
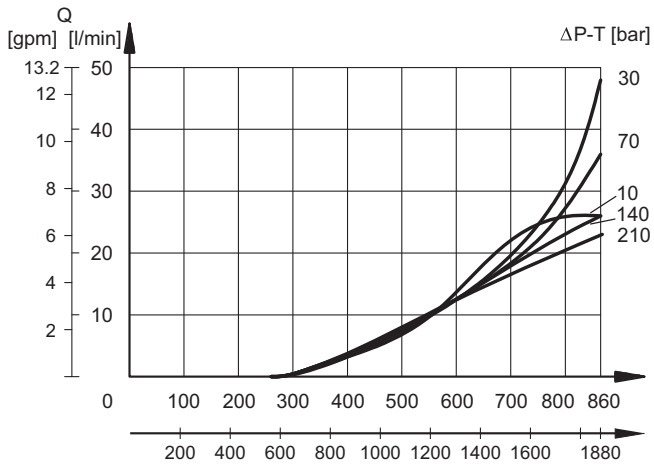

The proportional solenoid consists of tube and coil. The coil is mounted on the tube and fastened to it by a ring retainer.

The coils can be indexed to any position allowing for convenient location of the connector.

DUTY CYCLE	100%	
ELECTROMAGNETIC COMPATIBILITY (EMC)	according to European directive 2014/30/EU	
PROTECTION CLASS FOR INSULATION	copper wire	class H (180 °C)
	coil	class F (155 °C)

	Nominal voltage [V]	Resistance at 20 °C [Ω]	Current at 20 °C [A]	Coil codes for spare parts				
				K1	K2	K7	WK1	WK7
D12	12	4.4	1.88	1903080	1903100	1902940	1903590	1903580
D24	24	18.6	0.86	1903081	1903101	1902941	1903591	1903581

Declared IP degrees are intended according to EMC 2014/30/EU, only for both valve and connectors of an equivalent IP degree, installed properly.

WK1 and WK7 coils reach a better IP degree than standard coils thanks to the zinc-nickel plating and to some constructive measures. The valves with these coils have a salt spray resistance up to 600 hours (test performed according to UNI EN ISO 9227 and assessment test performed according to UNI EN ISO 10289).

K1

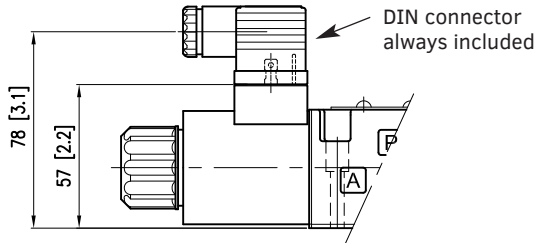

DIN 43650 (EN 175301-803)

IP degree of electrical connection: IP65
IP degree of whole valve: IP65

WK1

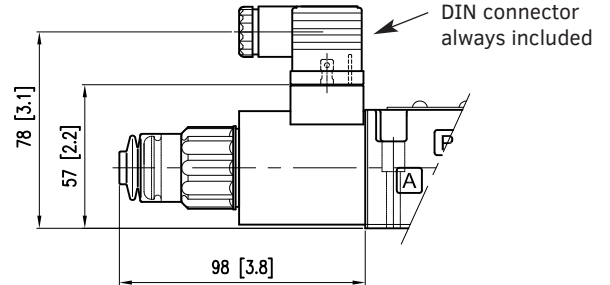

DIN 43650 (EN 175301-803)

Zinc-nickel plated coil.

IP degree of electrical connection: IP66
IP degree of whole valve: IP66

The pin for manual override is boot-protected (code B).

K2

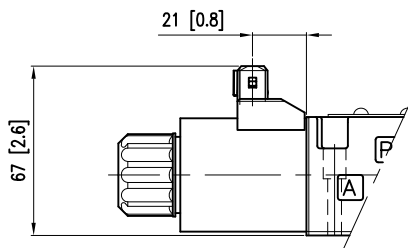

AMP Junior

IP degree of electrical connection: IP65/IP67
IP degree of whole valve: IP65

K7

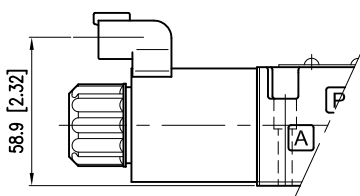

DEUTSCH DT04 MALE

IP degree of electrical connection: IP65/IP67
IP degree of whole valve: IP65

WK7

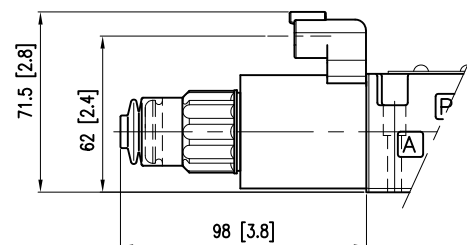

DEUTSCH DT04 MALE

Zinc-nickel plated coil.

IP degree of electrical connection: IP66/IP68/IP69 -
IP degree of whole valve: IP66/IP68/IP69
IP degree according to ISO 20653: IP69K

The pin for manual override is boot-protected (code B).

HDE3 DOUBLE SOLENOID (K7 COIL)

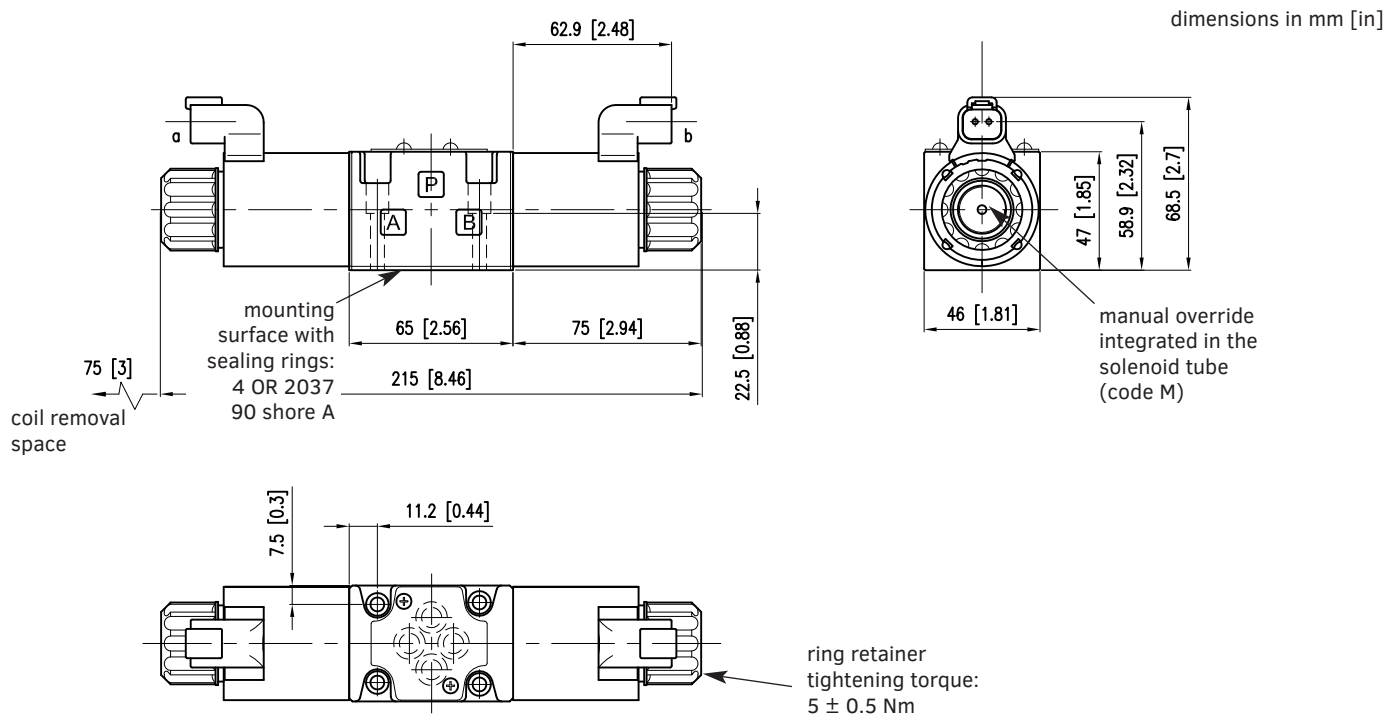

HDE3 SINGLE SOLENOID SIDE A (K7 COIL)

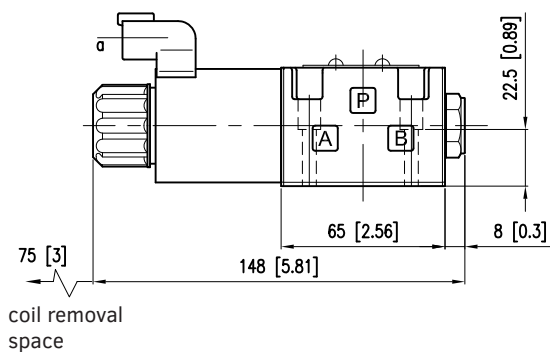

HDE3 SINGLE SOLENOID SIDE B (K7 COIL)

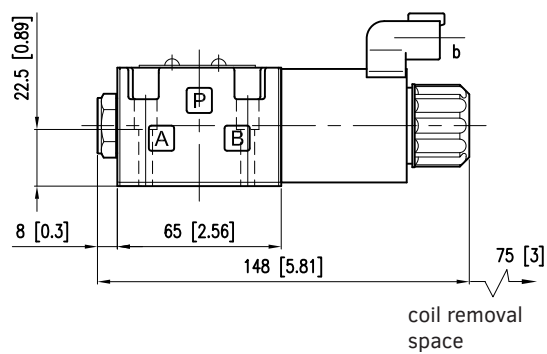

Fastening bolts:

4 SHCS M5x30 - ISO 4762 - torque 5 Nm (A 8.8)

Threads of mounting holes: M5x10

These valves have solenoids whose pin for manual operation is integrated in the tube (code M). Actuate this override by pushing it with a suitable tool, minding not to damage the sliding surface.

Further manual overrides are available, entering the proper code in the model number.

VERRIDE PINS INTEGRATED THE TUBE, BOOT PROTECTED

Code B

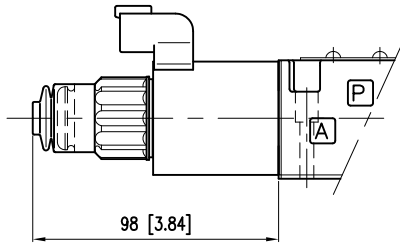

SCREW

Code S

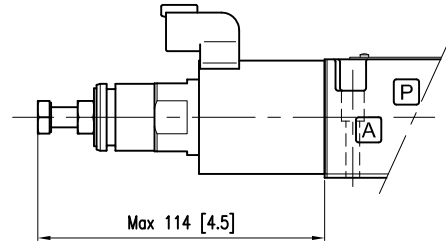

KNOB, TURNING

Code K

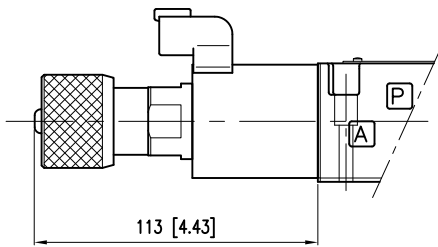

KNOB, TWIST AND LOCK

Code K2

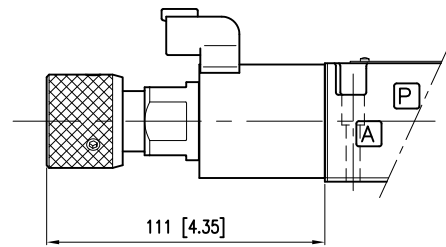

HAND LEVER

Code L, L1

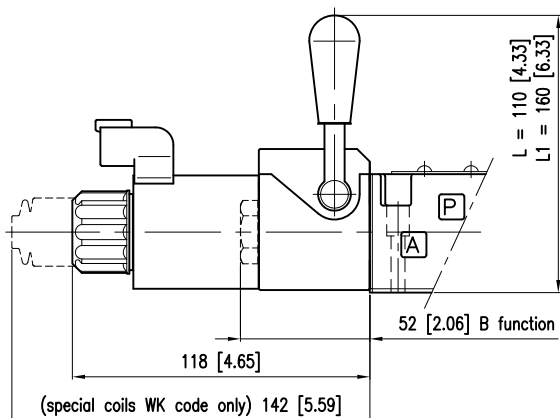

The lever device is always placed on side A. Valves with 'WK' coils are equipped with the boot for solenoid tube protection.

IP DEGREE TIPS

The technical reference standard for IP degree is IEC 60529, which classifies and rates the degree of protection provided by equipments and electrical enclosures against intrusions.

The first digit (6) concerns the protection from solid particles (body parts to dust).

The second digit of the IP rating concerns the liquid ingress protection. It indicates three different types of atmospheric agents from which protection is provided:

Values from 1 to 6 → water jets.

Values 7 and 8 → immersion.

Value 9 → high pressure and high temperature water jets.

This means that IP66 covers all the lower steps, rating IP68 covers IP67 but not IP66 and lower. Instead, IP69 does not cover any of them. Whether a device meets two types of protection requirements, it must be indicated by listing both separated by a slash. (E.g. a marking of an equipment covered both by temporary immersion and water jets is IP66/IP68).

INSTALLATION

These valves can be installed in any position without impairing correct operation.

Ensure that there is no air in the hydraulic circuit.

Valves are fixed by means of screws or tie rods on a flat surface with planarity and roughness equal to or better than those indicated in the relative symbols. If minimum values are not observed, fluid can easily leak between the valve and support surface.

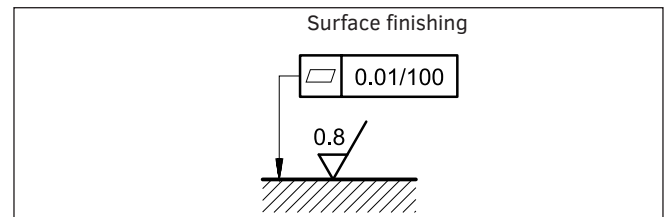

Supported by a worldwide network



CONTACT INFORMATION

EMEA

GERMANY	Hydreco Hydraulics GmbH, Straelen (NRW)	☎ +49 283494303-41	✉ info-de@hydreco.com
ITALY	Hydreco Hydraulics Italia Srl, Vignola (MO)	☎ +39 059 7700411	✉ sales-it@hydreco.com
ITALY	Hydreco Hydraulics Italia Srl, Parma (PR)	☎ +39 0521 1830520	✉ sales-it@hydreco.com
ITALY	Hydreco Srl, San Cesario S/P (MO)	☎ +39 059 330091	✉ cylinders@hydreco.com
NORWAY	Hydreco Hydraulics Norway AS, Nittedal	☎ +47 22909410	✉ post-no@hydreco.com
UK	Hydreco Hydraulics Ltd, Poole, Dorset	☎ +44 (0) 1202 627500	✉ info-uk@hydreco.com

AMERICAS

NORTH/LATIN	Hydreco Inc / Continental Hydraulics Inc, Shakopee (MN)	☎ +1 952 895 6400	✉ sales@conthyd.com
--------------------	---	-------------------	---------------------

APAC

AUSTRALIA	Hydreco Hydraulics Pty Ltd, Seven Hills (NSW)	☎ +61 2 9838 6800	✉ sales-au@hydreco.com
AUSTRALIA	Hydreco Hydraulics Pty Ltd, Welshpool (WA)	☎ +61 8 9377 2211	✉ reception-wa@hydreco.com
INDIA	Hydreco Hydraulics India Private Ltd, Bangalore	☎ +91 80 67656300	✉ sales-in@hydreco.com