

# HYDRECO

## HQE3

PROPORTIONAL  
FLOW CONTROL VALVE,  
COMPENSATED

250 bar 40 l/min

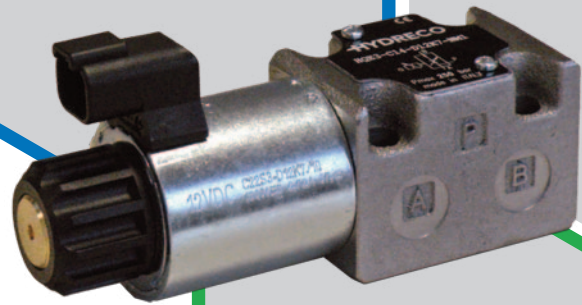

# TECHNICAL CATALOGUE

**INTRODUCTION**

The HQE3 valves are direct operated normally closed proportional flow control valves with pressure compensation, with porting pattern compliant to ISO 6263-03 standards.

These valves regulate flow in a hydraulic circuit. Output flow is directly proportional to the input current to the solenoid.

By closing the residual flow port (P) the valve can also be operated as a 2-way flow control valve. T port in the manifold must always be plugged.

2-way compensators are typically used in circuits supplied by variable volume pumps.

3-way compensators are typically used in circuits with fixed volume pumps. Connect 'P' port to the tank to use the valve as a bypass flow control.

**FLUIDS**

Use mineral oil-based hydraulic fluids HL or HM type, according to ISO 6743-4. For these fluids, use NBR seals.

For fluids HFDR type (phosphate esters) use FPM seals (code V). For the use of other kinds of fluid such as HFA, HFB, HFC, please consult our technical department.

Using fluids at temperatures higher than 80 °C (180 °F) causes the accelerated degradation of seals as well as the fluid physical and chemical properties.

From a safety standpoint, temperatures above 55 °C (130 °F) are not recommended.

**OPERATING PARAMETERS**

<b>MAXIMUM OP. PRESSURE</b>	all ports	250 bar	3600 psi
<b>REGULATED FLOW</b>		14 l/min 20 l/min 30 l/min 40 l/min	3.7 gpm 5.3 gpm 8.0 gpm 10.5 gpm
<b>COMPENSATOR SPRING</b>	HQE3-C14	4 bar	58 psi
	HQE3-C30		
	HQE3-C20	8 bar	116 psi
	HQE3-C40		
<b>MINIMUM PRESSURE DROP A TO B</b>	HQE3-C14	10 bar	145 psi
	HQE3-C30		
	HQE3-C20	22 bar	320 psi
	HQE3-C40		

<b>STEP RESPONSE</b>	0 → 100%	< 70 ms	
<b>HYSTERESIS</b>	% of Q max	< 6%	
<b>REPEATABILITY</b>	% of Q max	< ± 1.5%	
<b>VOLTAGE</b>		12V DC 24V DC	
<b>COIL CONNECTION</b>		DIN 43650	DT04-2P
<b>PROTECTION</b>	according IEC 60529	IP65	IP65/67
<b>WEIGHT</b>		1.6 kg	3.5 lbs

<b>RANGE TEMPERATURES:</b>	ambient	-20 to +54 °C	-4 to +130 °F
	fluid	-20 to +82 °C	-4 to +180 °F
<b>FLUID VISCOSITY</b>	range	10 - 400 cSt	60 - 1900 SUS
	recommended	25 cSt	120 SUS
<b>FLUID CONTAMINATION</b>		ISO 4406:1999 class 18/16/13	

**HYDRAULIC SYMBOLS**

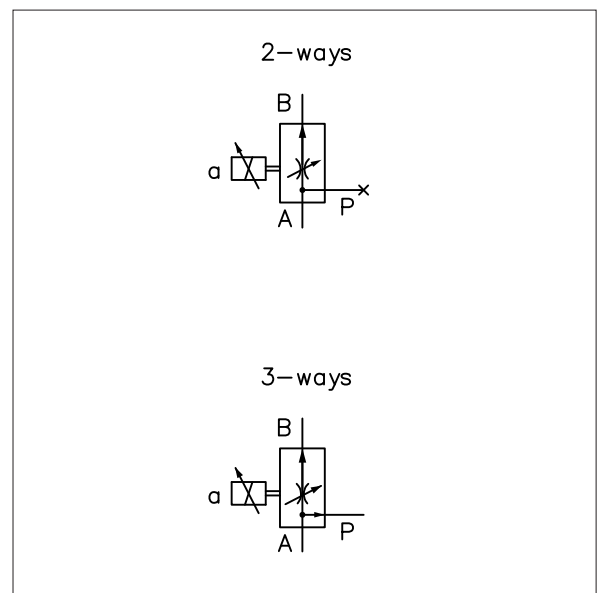

# HQE3 - C ■ - ■ ■ - ■ ■ - 1

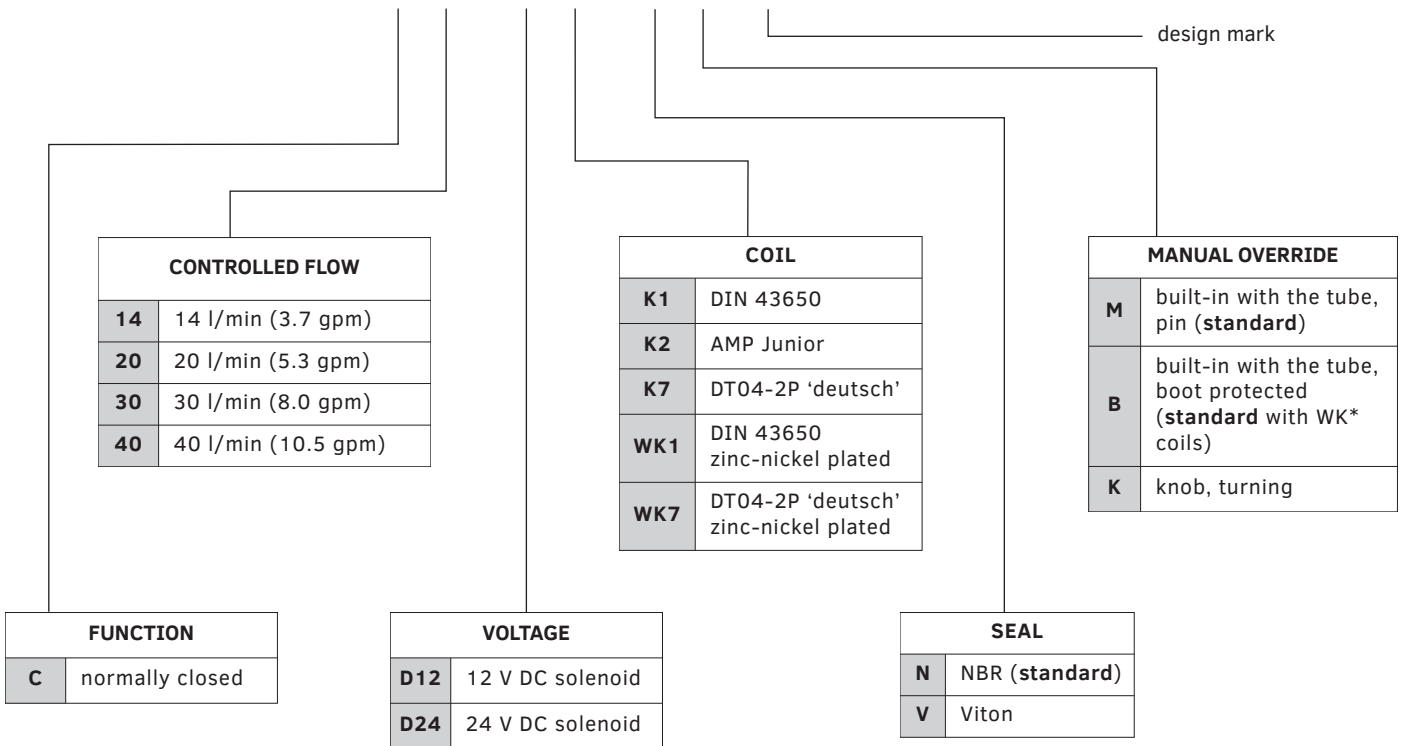

**CODE EXAMPLE:**  
 HQE3 - C14 - D12K7 - NM - 1

Typical flow rate characteristics A → B depending on the current supplied to the solenoid (D24 version, maximum current 860 mA, PWM 100 Hz)

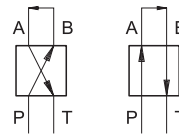

2-WAYS FLOW CONTROL Q = F (COMMAND)

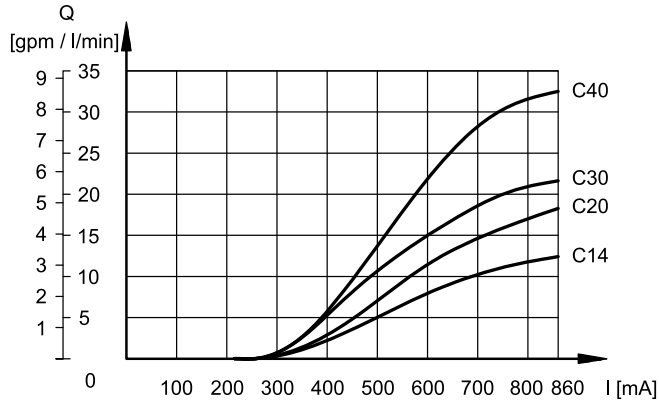

2-WAYS FLOW CONTROL Q = F (PRESSURE IN B)

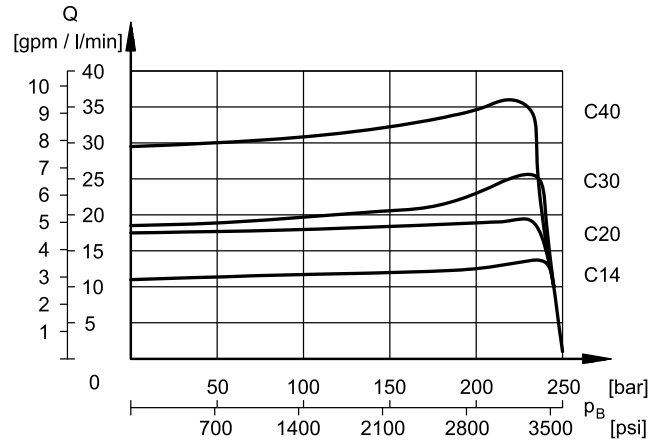

3-WAYS FLOW CONTROL Q = F (COMMAND)

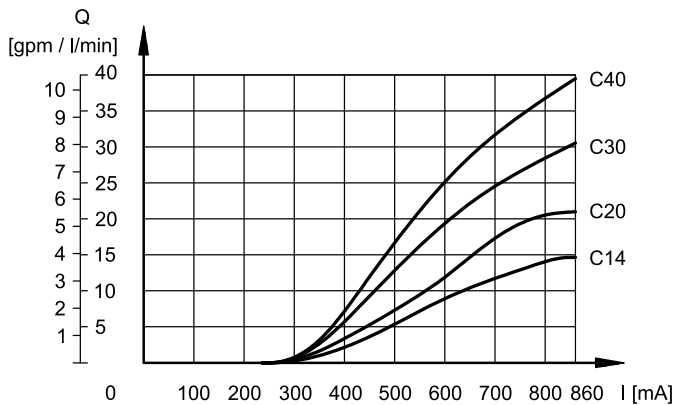

3-WAYS FLOW CONTROL Q = F (PRESSURE IN B)

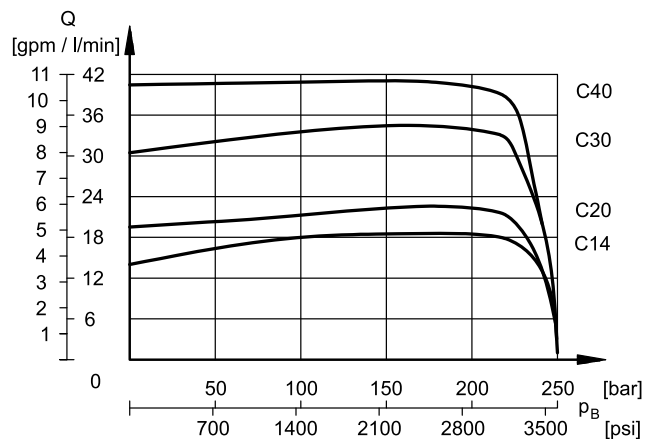

PRESSURE DROPS  $\Delta p$  A→P ( $Q_B = 0$ )

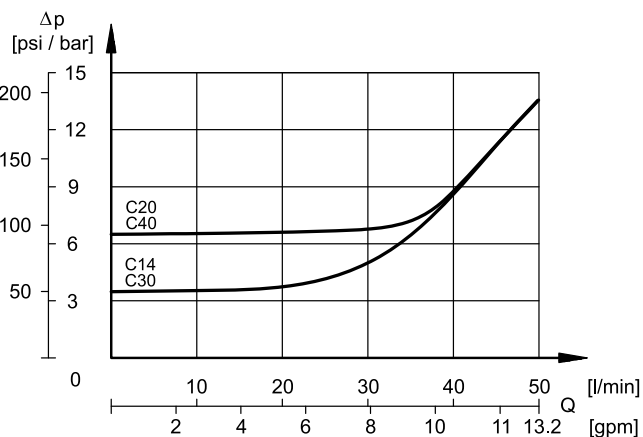

Pressure drops with flow A→P.  
 Obtained with  $Q_B = 0$   
 (de-energised coil - no current)

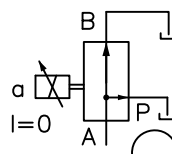

The proportional solenoid consists of tube and coil. The coil is mounted on the tube and fastened to it by a ring retainer.

The coils can be indexed to any position allowing for convenient location of the connector.

<b>DUTY CYCLE</b>	100%	
<b>ELECTROMAGNETIC COMPATIBILITY (EMC)</b>	according to European directive 2014/30/EU	
<b>PROTECTION CLASS FOR INSULATION</b>	copper wire	class H (180 °C)
	coil	class F (155 °C)

	Nominal voltage [V]	Resistance at 20 °C [Ω]	Current at 20 °C [A]	Coil codes for spare parts				
				<b>K1</b>	<b>K2</b>	<b>K7</b>	<b>WK1</b>	<b>WK7</b>
<b>D12</b>	12	4.4	1.88	1903080	1903100	1902940	1903590	1903580
<b>D24</b>	24	18.6	0.86	1903081	1903101	1902941	1903591	1903581

Declared IP degrees are intended according to EMC 2014/30/EU, only for both valve and connectors of an equivalent IP degree, installed properly.

WK1 and WK7 coils reach a better IP degree than standard coils thanks to the zinc-nickel plating and to some constructive measures. The valves with these coils have a salt spray resistance up to 600 hours (test performed according to UNI EN ISO 9227 and assessment test performed according to UNI EN ISO 10289).

**K1**

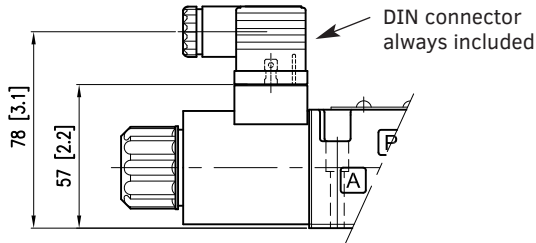

**DIN 43650 (EN 175301-803)**

IP degree of electrical connection: IP65  
 IP degree of whole valve: IP 65

**WK1**

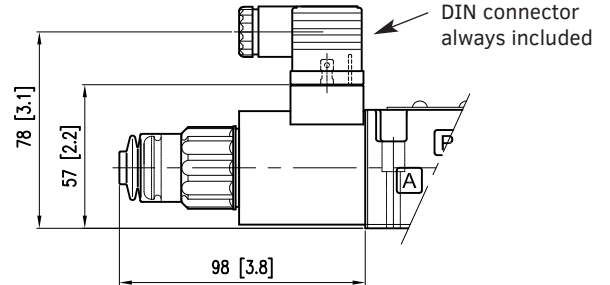

**DIN 43650 (EN 175301-803)**

Zinc-nickel plated coil.

IP degree of electrical connection: IP66  
 IP degree of whole valve: IP66

The pin for manual override is boot-protected (code B).

**K2**

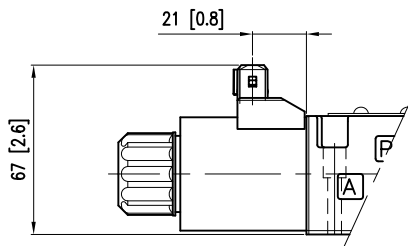

**AMP Junior**

IP degree of electrical connection: IP65/IP67  
 IP degree of whole valve: IP 65

**K7**

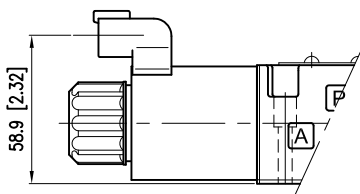

**DEUTSCH DT04 MALE**

IP degree of electrical connection: IP65/IP67  
 IP degree of whole valve: IP 65

**WK7**

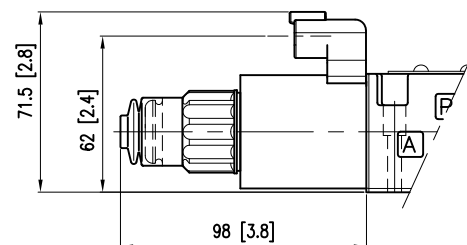

**DEUTSCH DT04 MALE**

Zinc-nickel plated coil.

IP degree of electrical connection: IP66/IP68/IP69 -  
 IP degree of whole valve: IP66/IP68/IP69  
 IP degree according to ISO 20653: IP69K

The pin for manual override is boot-protected (code B).

dimensions in mm [in]

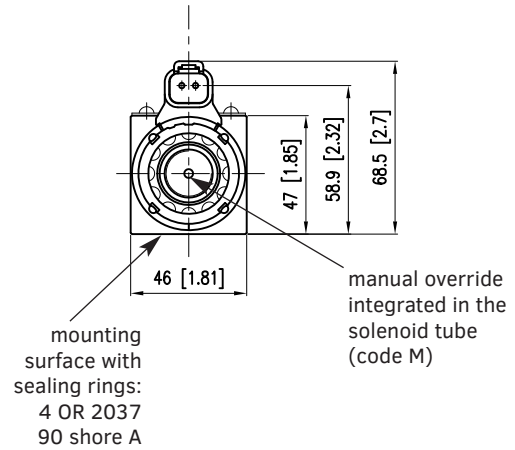
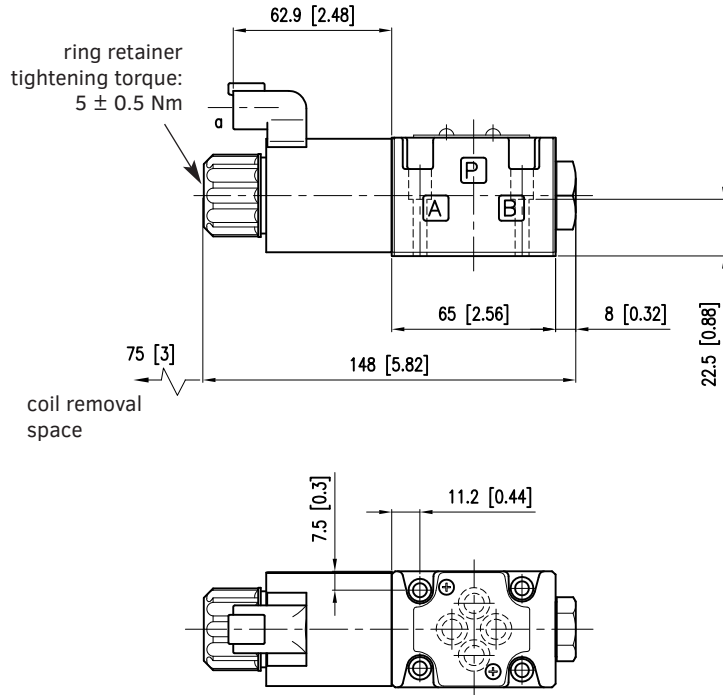

**Fastening bolts:**

4 SHCS M5x30 - ISO 4762 - torque 5 Nm (A 8.8)

**Threads of mounting holes:** M5x10

**OPERATION DEPENDING ON PORTS IN THE MOUNTING INTERFACE**

The valve has all the ports indicated in ISO 6263-03-03-\*-97 standard. The correct operation depends on how the mounting interface is realized.

The T port must not be present in the mounting interface.

The P port acts as discharge for residual flow.

If the P port is not even created, the valve works as restrictive compensator, 2-ways.

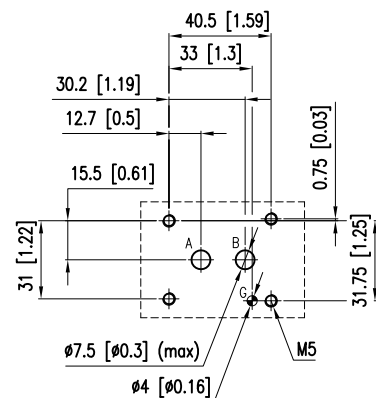
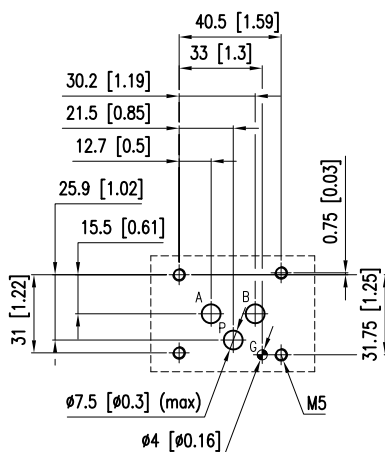
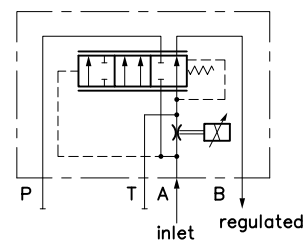
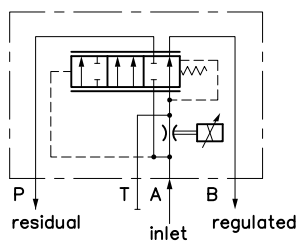

These valves have solenoids whose pin for manual operation is integrated in the tube (code M). Actuate this override by pushing it with a suitable tool, minding not to damage the sliding surface.

Further manual overrides are available, entering the proper code in the model number.

**OVERRIDE PINS INTEGRATED THE TUBE, BOOT PROTECTED**

Code B

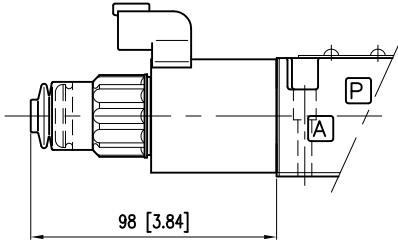

**KNOB, TURNING**

Code K

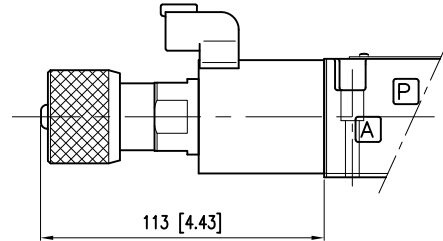



### IP DEGREE TIPS

The technical reference standard for IP degree is IEC 60529, which classifies and rates the degree of protection provided by equipments and electrical enclosures against intrusions.

The first digit (6) concerns the protection from solid particles (body parts to dust).

The second digit of the IP rating concerns the liquid ingress protection. It indicates three different types of atmospheric agents from which protection is provided:

Values from 1 to 6 → water jets.

Values 7 and 8 → immersion.

Value 9 → high pressure and high temperature water jets.

This means that IP66 covers all the lower steps, rating IP68 covers IP67 but not IP66 and lower. Instead, IP69 does not cover any of them. Whether a device meets two types of protection requirements it must be indicated by listing both separated by a slash. (E.g. a marking of an equipment covered both by temporary immersion and water jets is IP66/IP68).

### INSTALLATION

These valves can be installed in any position without impairing correct operation.

Ensure that there is no air in the hydraulic circuit.

Valves are fixed by means of screws or tie rods on a flat surface with planarity and roughness equal to or better than those indicated in the relative symbols. If minimum values are not observed, fluid can easily leak between the valve and mounting surface.

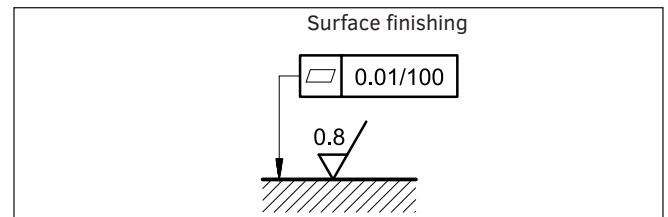

Supported by a worldwide network



## CONTACT INFORMATION

### EMEA

<b>GERMANY</b>	Hydreco Hydraulics GmbH, Straelen (NRW)	☎ +49 283494303-41	✉ info-de@hydreco.com
<b>ITALY</b>	Hydreco Hydraulics Italia Srl, Vignola (MO)	☎ +39 059 7700411	✉ sales-it@hydreco.com
<b>ITALY</b>	Hydreco Hydraulics Italia Srl, Parma (PR)	☎ +39 0521 1830520	✉ sales-it@hydreco.com
<b>ITALY</b>	Hydreco Srl, San Cesario S/P (MO)	☎ +39 059 330091	✉ cylinders@hydreco.com
<b>NORWAY</b>	Hydreco Hydraulics Norway AS, Nittedal	☎ +47 22909410	✉ post-no@hydreco.com
<b>UK</b>	Hydreco Hydraulics Ltd, Poole, Dorset	☎ +44 (0) 1202 627500	✉ info-uk@hydreco.com

### AMERICAS

<b>NORTH/LATIN</b>	Hydreco Inc / Continental Hydraulics Inc, Shakopee (MN)	☎ +1 952 895 6400	✉ sales@conthyd.com
--------------------	---	-------------------	---------------------

### APAC

<b>AUSTRALIA</b>	Hydreco Hydraulics Pty Ltd, Seven Hills (NSW)	☎ +61 2 9838 6800	✉ sales-au@hydreco.com
<b>AUSTRALIA</b>	Hydreco Hydraulics Pty Ltd, Welshpool (WA)	☎ +61 8 9377 2211	✉ reception-wa@hydreco.com
<b>INDIA</b>	Hydreco Hydraulics India Private Ltd, Bangalore	☎ +91 80 67656300	✉ sales-in@hydreco.com